

Quality management system (QMS)
of LLC «Volya» is certified
for compliance with
standard of
ISO 9001:2008



Certified by
Russian Registry



VOLYA LLC

DACHNAY TRYOSHKA

Cellular polycarbonate greenhouse
(EURO)

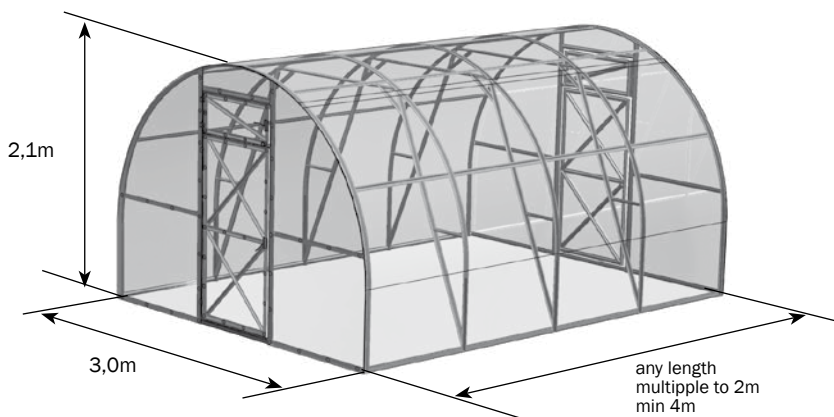

Technical certificate

page 2-9

Assembling manual

page 10-30

! Perform assembling and operation of the greenhouse in strict accordance with the manual and operating rules stated in the technical certificate. Please keep this technical certificate for further reference.

Description

Dachnaya Tryoshka greenhouse is designed for creation microclimate favorable for growing garden crops on cottage and household plots.

Greenhouse might have variable length depending on customers' desire. Required length of greenhouse is provided by purchasing of packages with extending inserts. Each insert add 2 m to base length. Base length is 4m. Height of installed frame is 2.1 m

The frame of the greenhouse is made of galvanized iron and is to be assembled with screws and nuts. Greenhouse is fixed on the ground by digging special frame endings or on fundament using angles. Complete set includes all that is needed for fastening of coverage. Greenhouse may be completed with coverage on buyer's request. Greenhouse has two door openings and two small windows in opposite ends.

Greenhouse base requires 3 sheets of cellular polycarbonate 2.1x6 m with 4-6mm thickness. For each Inserts - 1 sheet of cellular polycarbonate 2.1x6 m

Operation rules

Before the start of operation, the greenhouse should be assembled and installed as prescribed in the manual. When the greenhouse is assembled by a third party the customer should supervise the quality of works to ensure compliance with the present manual. Some detail have extra holes due to uniformity of details. During assembly, be careful not to damage the parts, because until they assembled fully, they do not have sufficient rigidity. Use supports (e.g., chairs) at intermediate stages of assembly to evenly raise the assembled frame. To align the holes in difficult joints use a nail with a diameter of 4mm or mandrel with a conical end. During assembly of the frame details' connections should be implemented for all specified openings. Simplified connection of the parts is a violation of assembly rules and cause of removal warranty support by manufacturer.

Do not install the greenhouse too close to buildings or trees where masses of snow/ice can fall on it. Recommended distance is at least 2 m. The greenhouse is designed to withstand wind at the speed below 24 m/sec. The greenhouse cladding should not be removed for the winter period if snow load is limited. If the greenhouse is left unattended for the entire winter the customer should either remove the cladding or estimate the possible snow load. For the frame assembled with all parts including strainers and braces, the maximal snow load begins when the layer of snow weight is 180 kg per 1 sqm of horizontal surface, which corresponds to regulative snow load of IV snow region (in accordance with Classification of Building rules and regulation 2/01/07-85 «Workload and impacts»). For the greenhouse which was installed according to the rules, manufacturer guarantee sufficient strength against snow load in the following areas: Northern areas in Russia, the Scandinavian countries: Finland, Sweden, Norway, Denmark.

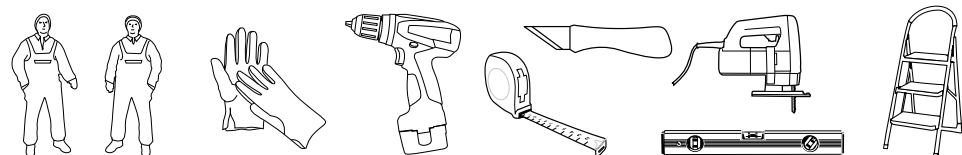

Cleaning and washing sheets of polycarbonate.

1. Rinse the sheet with warm water.
2. Wash the sheet with a solution of mild soap or with a household detergent and warm water, using a soft rag or a sponge to remove dirt.
3. Rinse with cold water and wipe with a soft cloth.

Never use abrasives or highly alkaline cleaning compositions for cleaning polycarbonate sheets. Dry rubbing of the surface will damage the protective layer of the cladding and shorten its shelf life. Never rub the surface of polycarbonate sheets with brushes, metallic cloth or other abrasive materials.

When disinfecting the greenhouse from pathogens causing fungal and bacterial diseases, do not use «sulfur blocks» to avoid frame corrosion (blackening).

Warranty liabilities

1. The manufacturer is responsible for the completeness of the product.
2. The manufacturer is responsible for assemblability of the greenhouse in accordance with the instructions.
3. The manufacturer is responsible for the greenhouse durability in the specified weather conditions.
4. Term for making claims is 24 months from the day of purchase

Terms of warranty provisions

Warranty does not apply to cases of:

1. Greenhouse installation in violation of instruction requirements
2. Violation of the rules of operation.
3. Inappropriate use of the greenhouse.
4. Deformation of the greenhouse as a result of ground movement.
5. Floods, hurricanes and other natural disasters.









Production date









Manufacturing facility: LLC "Volya"
141983, Dubna, Moscow region, Severnyi per., 8.

The manufacturer is responsible for the quality of products in accordance with the RF Civil Code.
The company reserves the right to make changes in the greenhouse design

DETAILED PARTS LIST BASE









Box №1









№	marking	length, m	quantity
1	4н	L=1,62 	6
2	4в	L=1,62 	3
3	4вк	L=1,62 	2
4	4нкп	L=1,62 	2
5	4нкл	L=1,62 	2
6	1	L=0,92 	10
7	2в	L=0,96 	12
8	9-1	L=0,98 	4

№	marking	length, m	quantity
9	9-2л	L=1,4 	2
10	9-2п	L=1,4 	2
11	17	L=1,4 	3
12	18	L=1,1 	6
13	19	L=0,99 	6
14	20	L=0,34 	6
15	21	L=0,35 	6
16	-	 end amplifier	4

DETAILED PARTS LIST BASE

















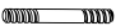





Box №2



№	marking	length, m	quantity
1	2	L=0,96 	24
2	3	L=0,14 	14
3	5	L=0,09 	4
4	8	L=1,04 	4
5	10	L=0,82 	4
6	11-л	L=1,02 	2
7	11-п	L=1,02 	2
8	12д	L=0,75 	8

№	marking	length, m	quantity
9	12ф	L=0,32 	4
10	13д	L=0,71 	6
11	13ф	L=0,71 	4
12	14	L=0,95 	4
13	15	L=1,0 	4
14	16	L=0,73 	2
15	-	L=1,05 	4
16	-	L=1,0 	4

DETAILED PARTS LIST BASE























Box №2

№	name	quantity	№	name	quantity
17	loops for doors and windows 	8	27	screw M4 x 8 	534
18	tube bend spinner 	1	28	screw M4 x 10 	50
19	handle 	8	29	screw M4 x 25 	132
20	pin 	4	30	screw M4 x 35 	32
21	bracket 	8	31	self-tapping screw 	6
22	bracket for the hook 	8	32	bolt M6 x 60 	10
23	hook for doors and windows 	4	33	nut M6 	10
24	workpiece for locking (turner with 2 elastic nozzles) 	4	34	nut M4 	748
25	top bandage 	5	35	washer 	160
26	bottom bandage 	10	36	washer 6 	20
			37	tape 	1
			38	double-sided tape L=10 m 	1

№	name	length, m
39	seal loop 	3,7
40	seal door 	10
41	seal side wall 	12

DETAILED PARTS LIST EXTENSION

Box №1

№	marking	length, m	quantity	№	name	quantity
1	1	L=0,92 	4	13	top bandage 	2
2	2	L=0,96 	12	14	bottom bandage 	4
3	2B	L=0,96 	6	15	bolt M6 x 60 	4
4	3	L=0,14 	4	16	nut M6 	4
5	4H	L=1,62 	4	17	washer 6 	8
6	4B	L=1,62 	2	18	double-sided tape L=5 m 	1
7	17	L=1,4 	2	19	screw M4 x 8 	184
8	18	L=1,1 	4	20	screw M4 x 25 	24
9	19	L=0,99 	4	21	nut M4 	208
10	20	L=0,34 	4	22	washer 	16
11	21	L=0,35 	4			
12	-	L=1,0 	4			

General view of the frame of Dachnaya Tryoshka Greenhouse

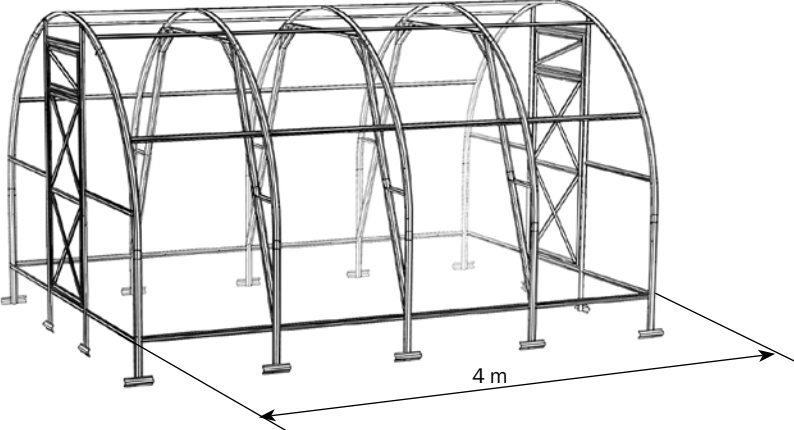

General view of the insert for Dachnaya Tryoshka greenhouse

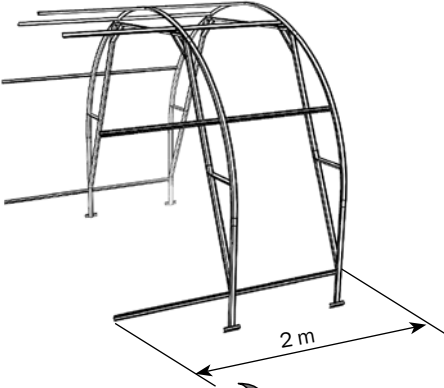

General view of the frame of greenhouse, extendable inserts

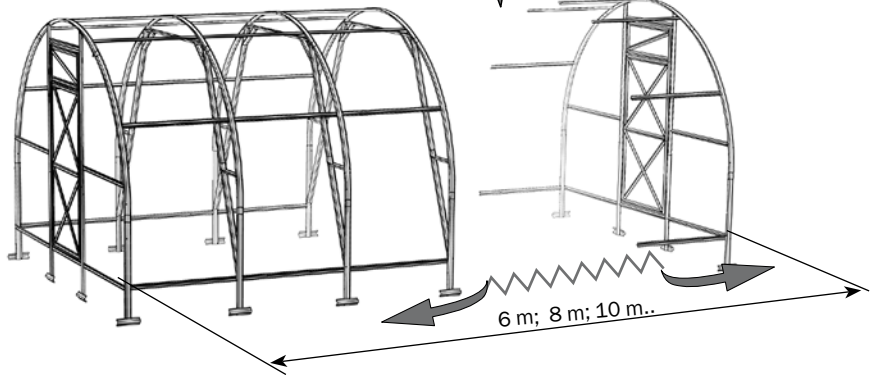

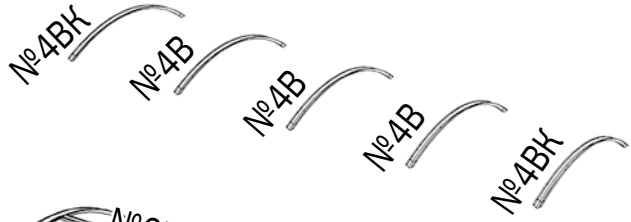
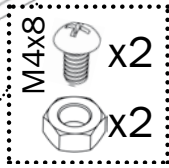
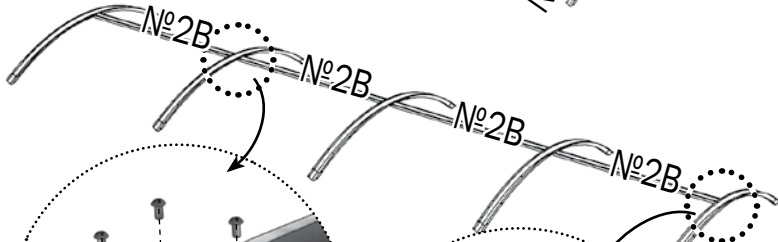
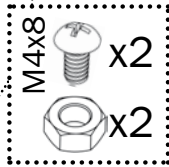
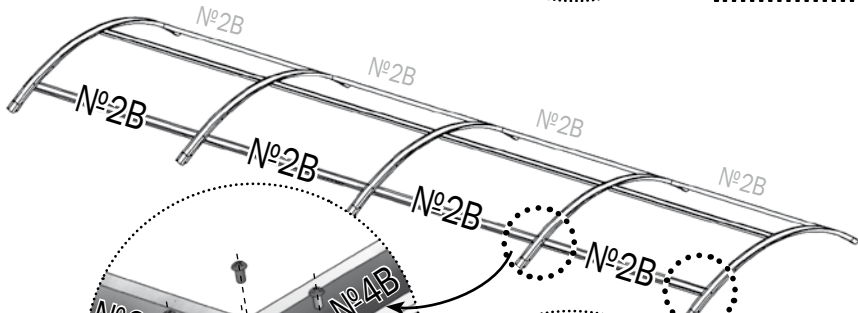
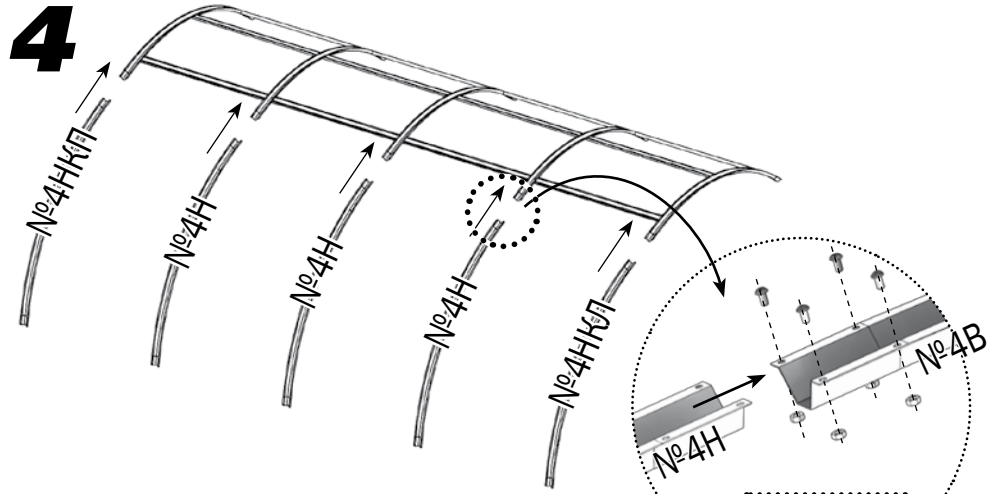
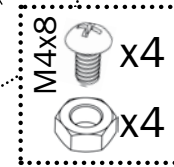
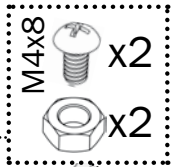
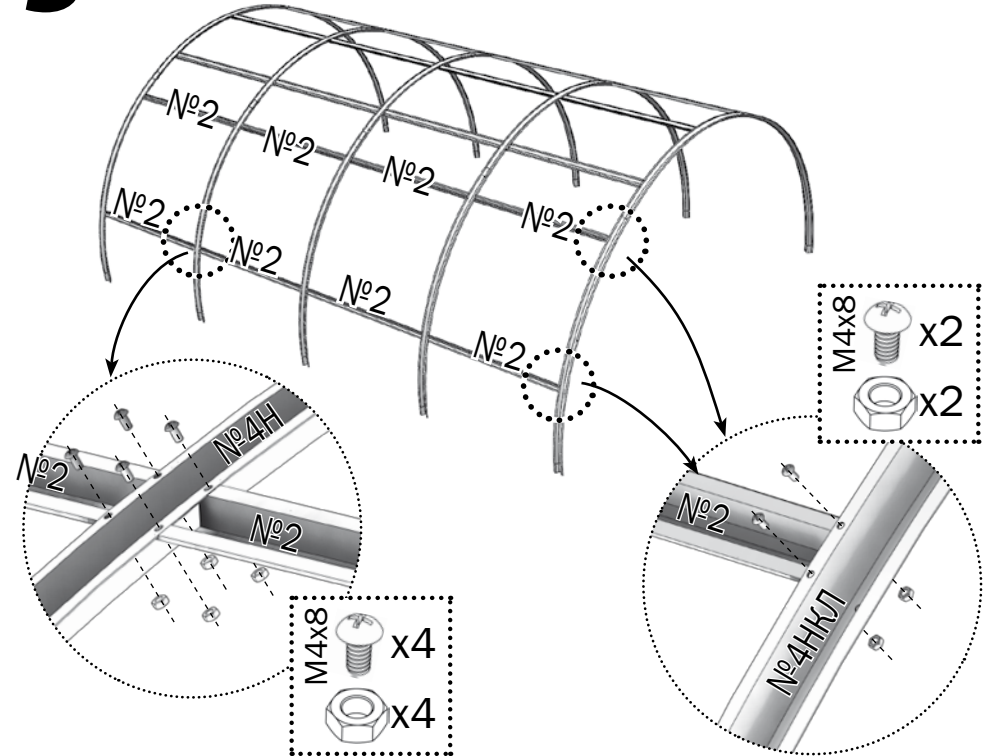
1**2****3****4****5**

6

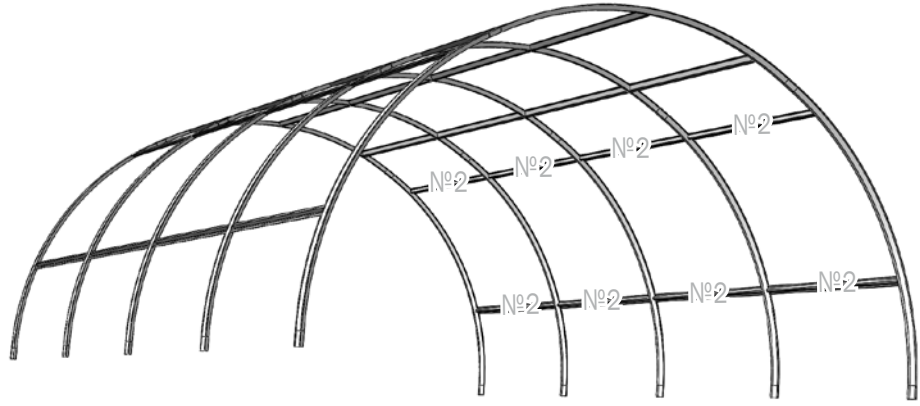

7

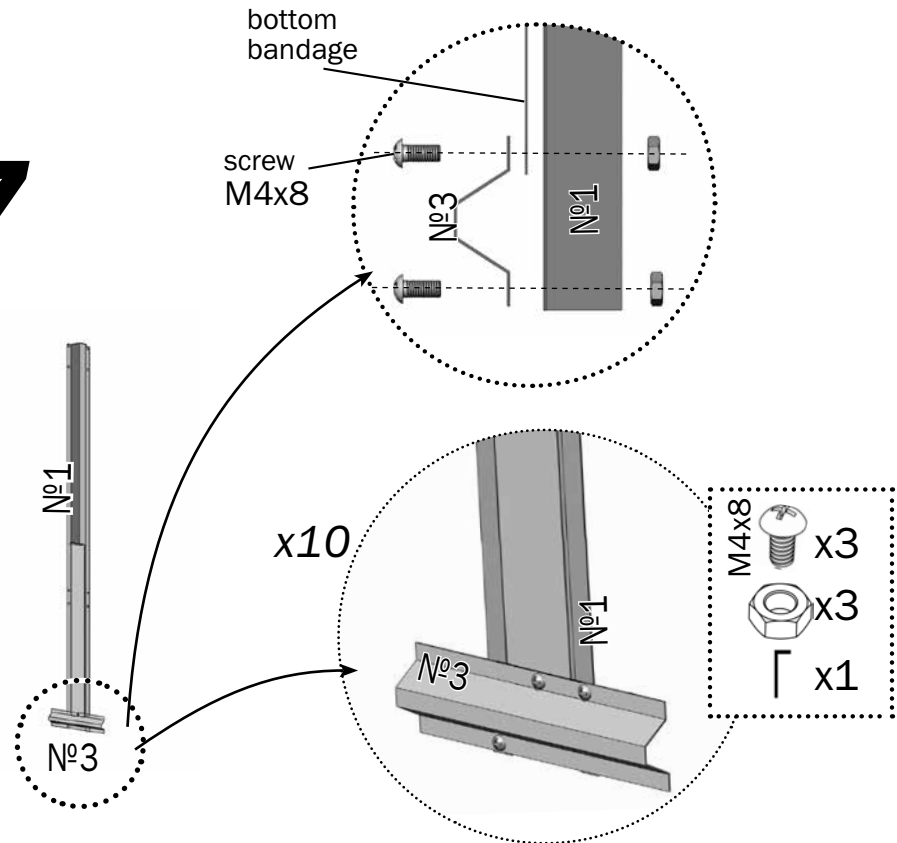

8

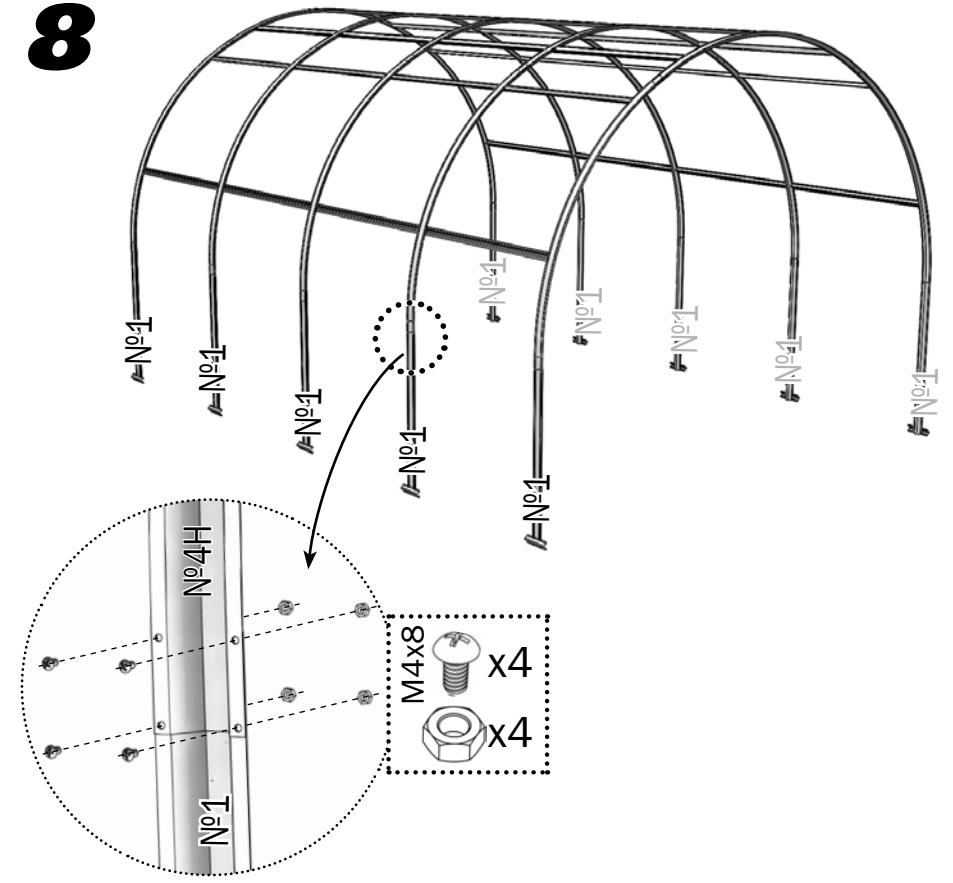

9

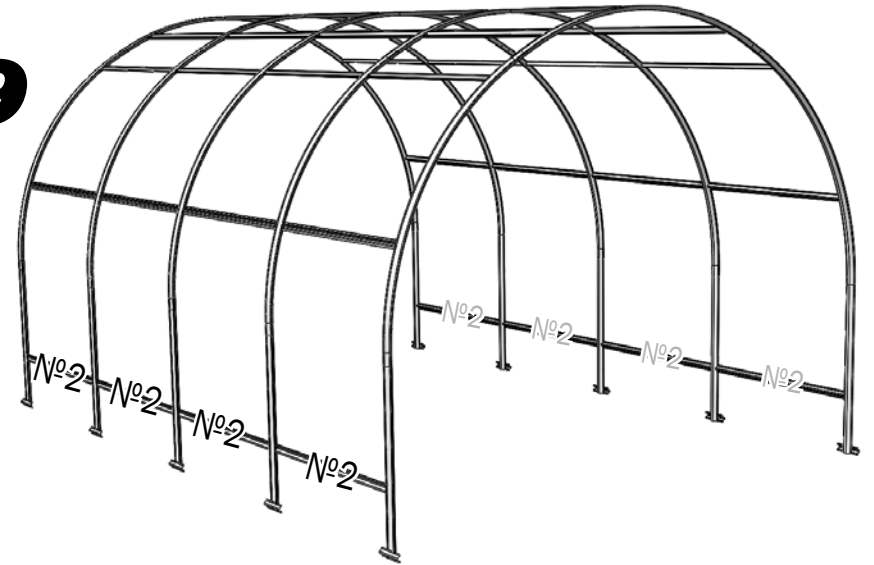

10

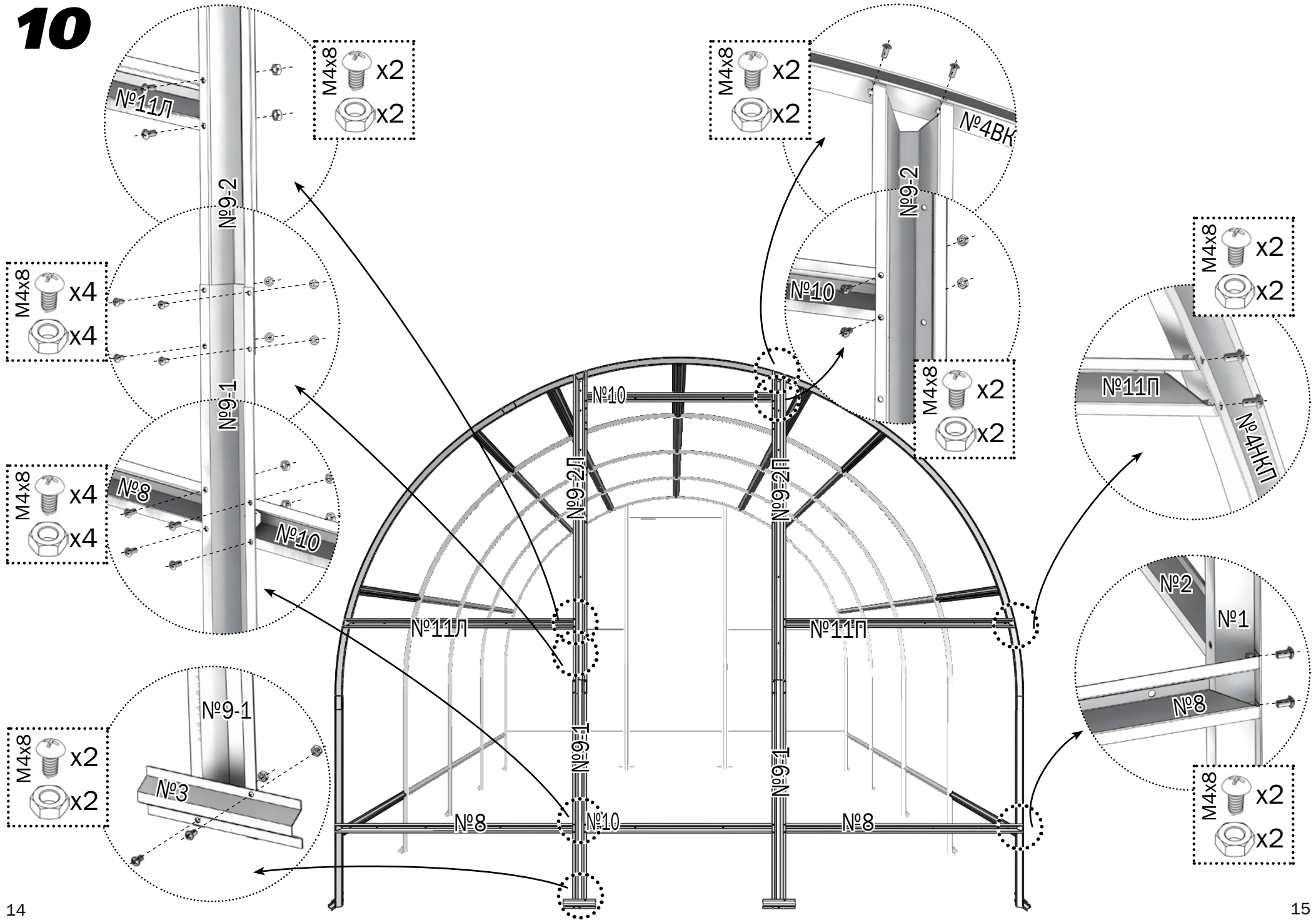

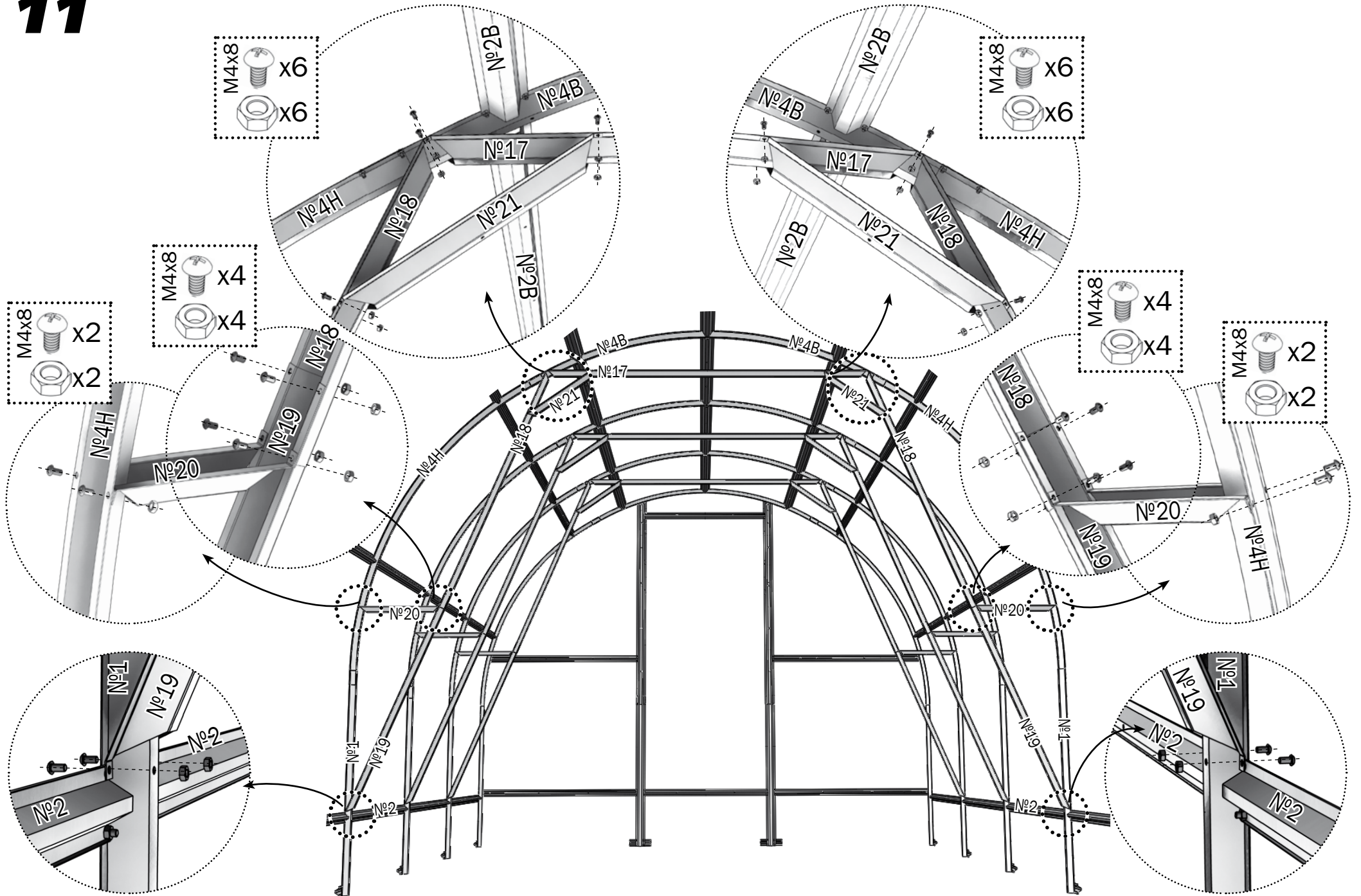

12

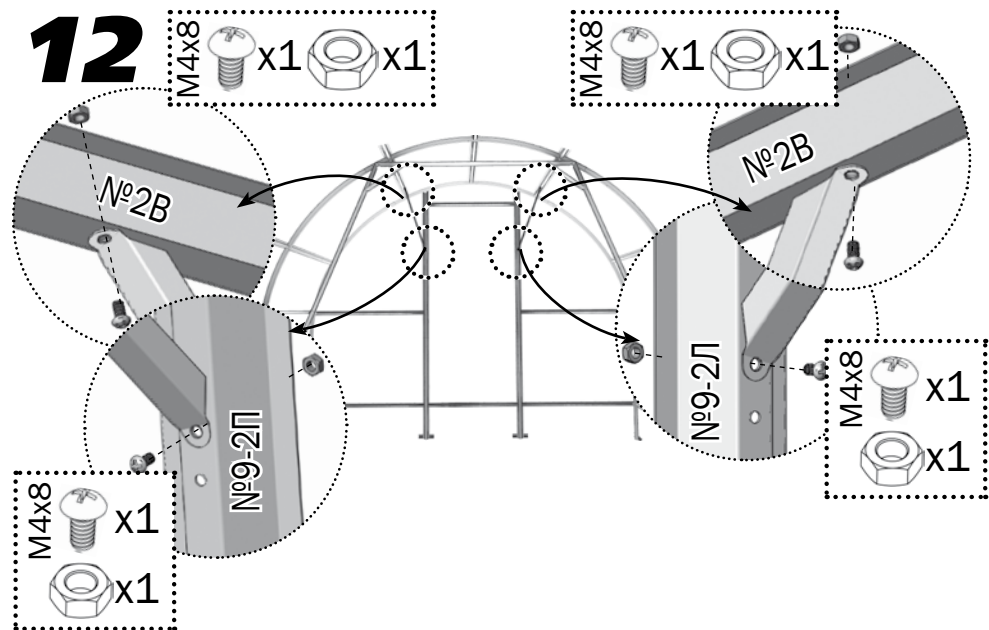

13

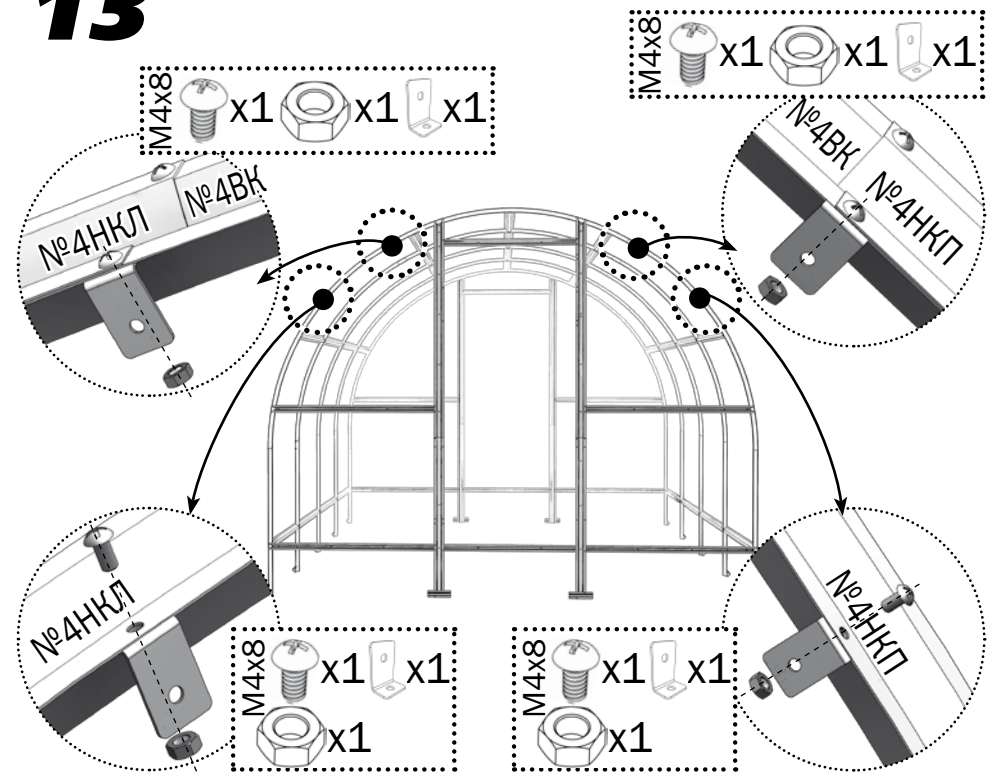

14

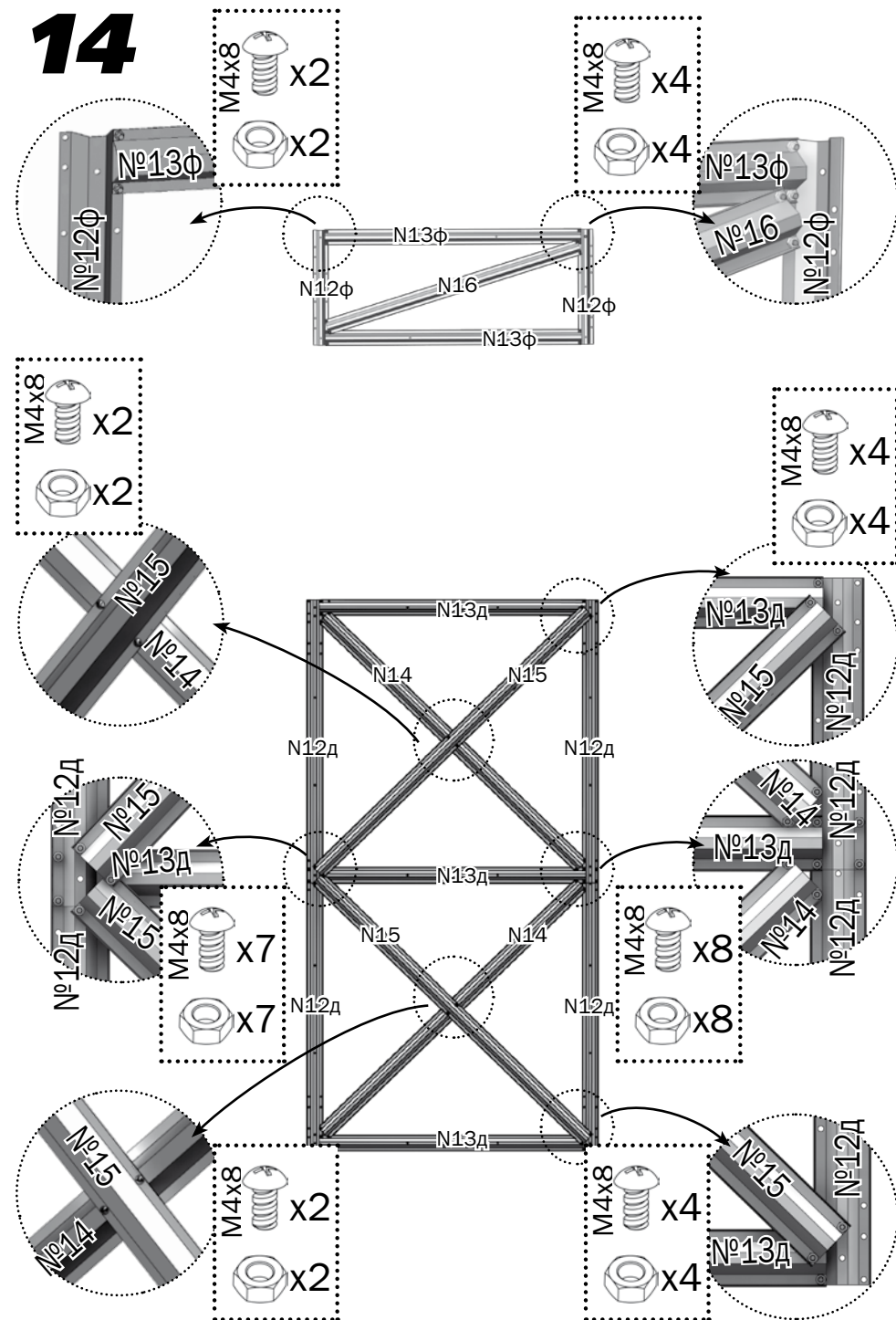

15

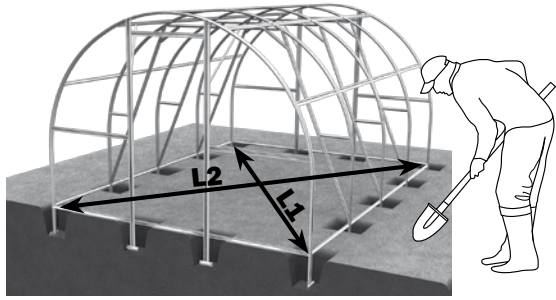

16

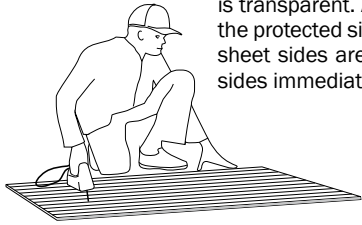

Cellular polycarbonate shall be installed strictly defined side out (towards the sun), which has a protective layer. The protective layer is usually at the side with the inscriptions on the transport film. The film on the other side of sheet is transparent. After marking the sheet, but prior to its cutting, make a mark on the protected side of the sheet for each piece: after removal of the transport film sheet sides are not visually different. The transport film is stripped from both sides immediately before fixing the cladding on the frame.

Sections of polycarbonate with open honeycombs should be covered by adhesive tape.

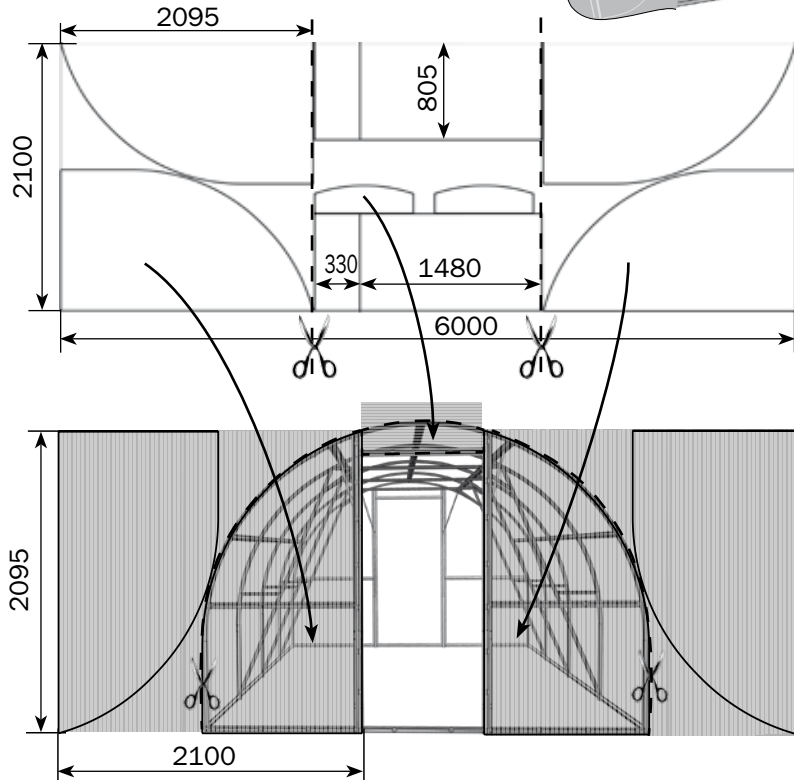
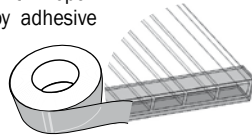

17

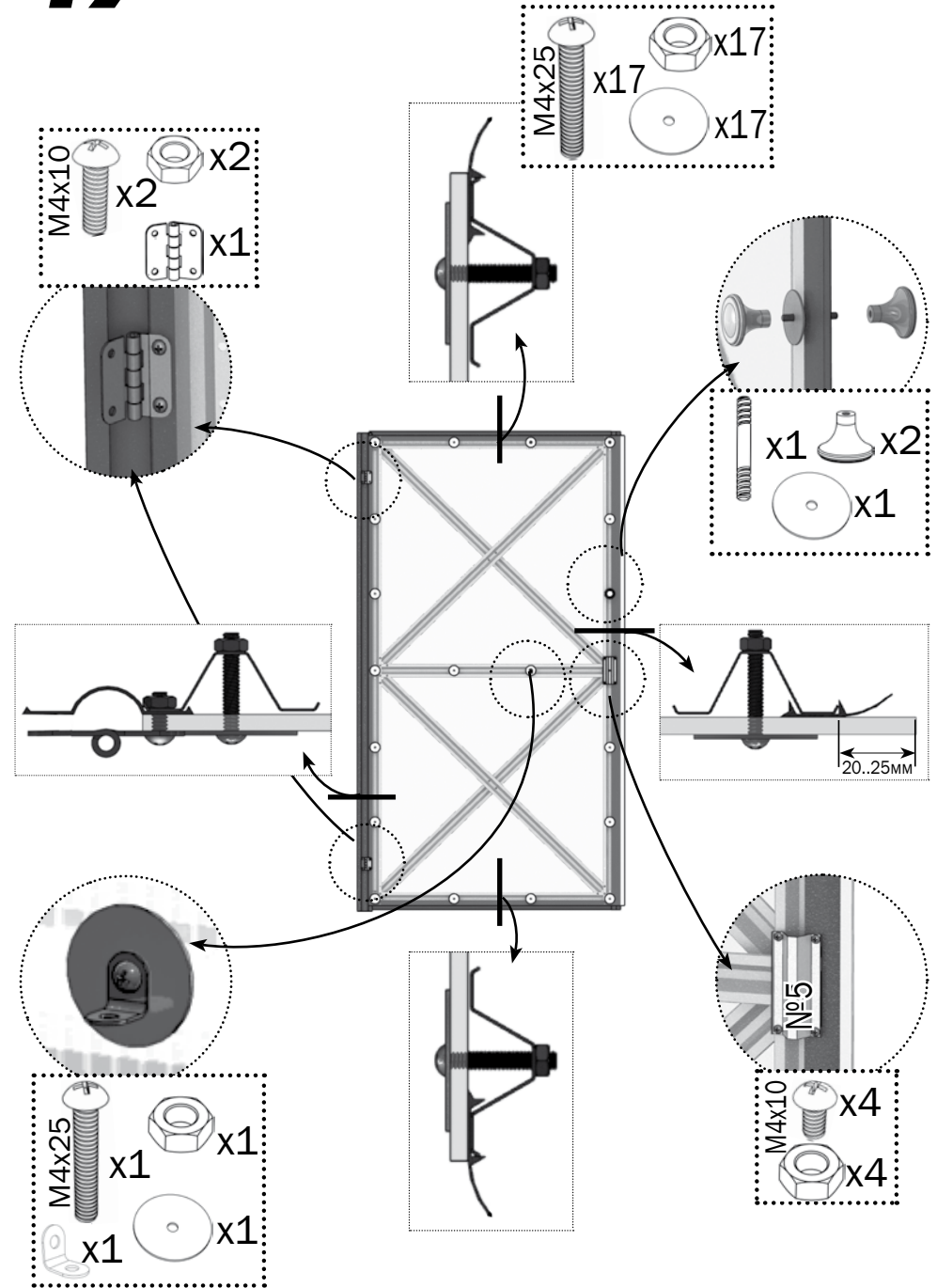

18

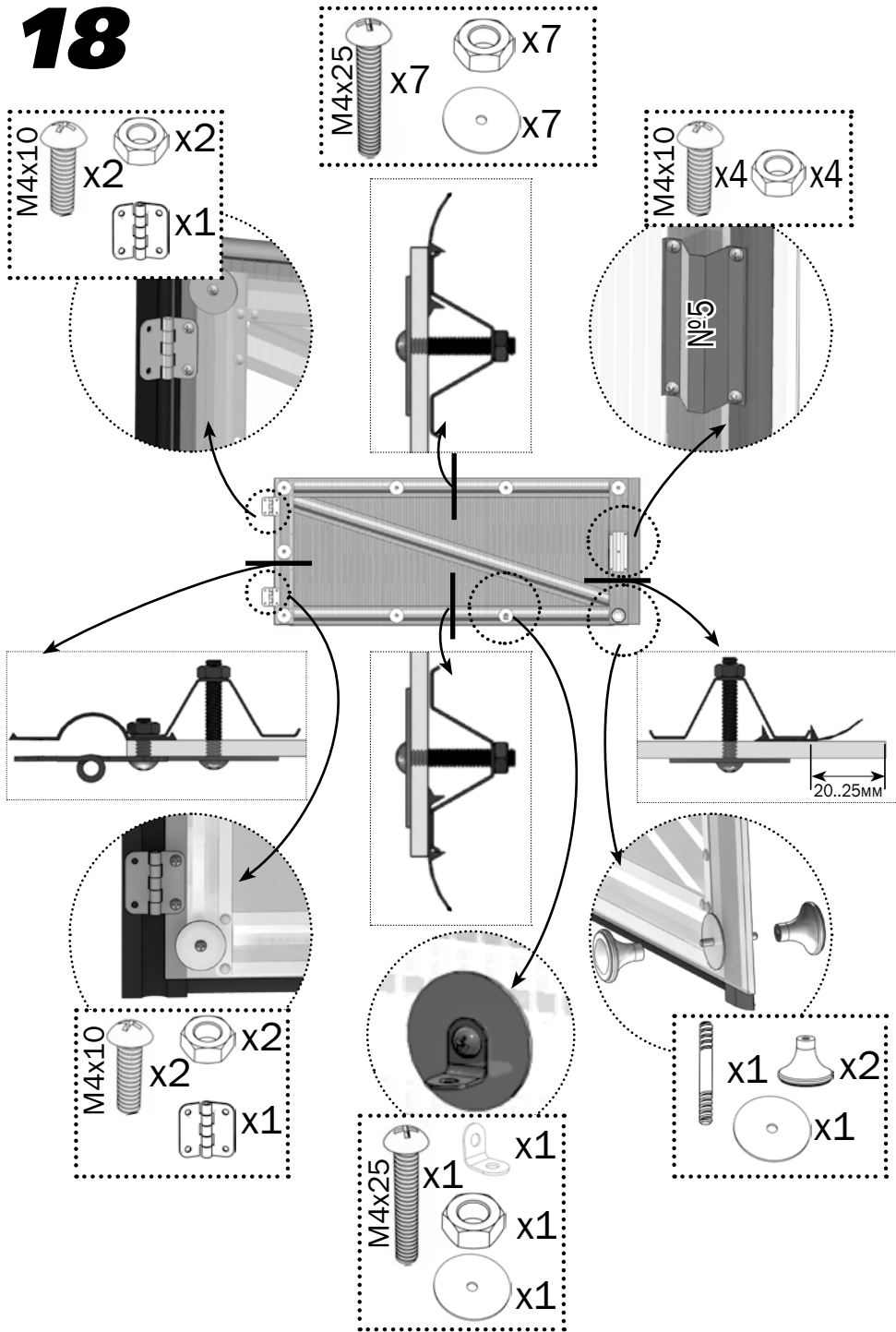

19

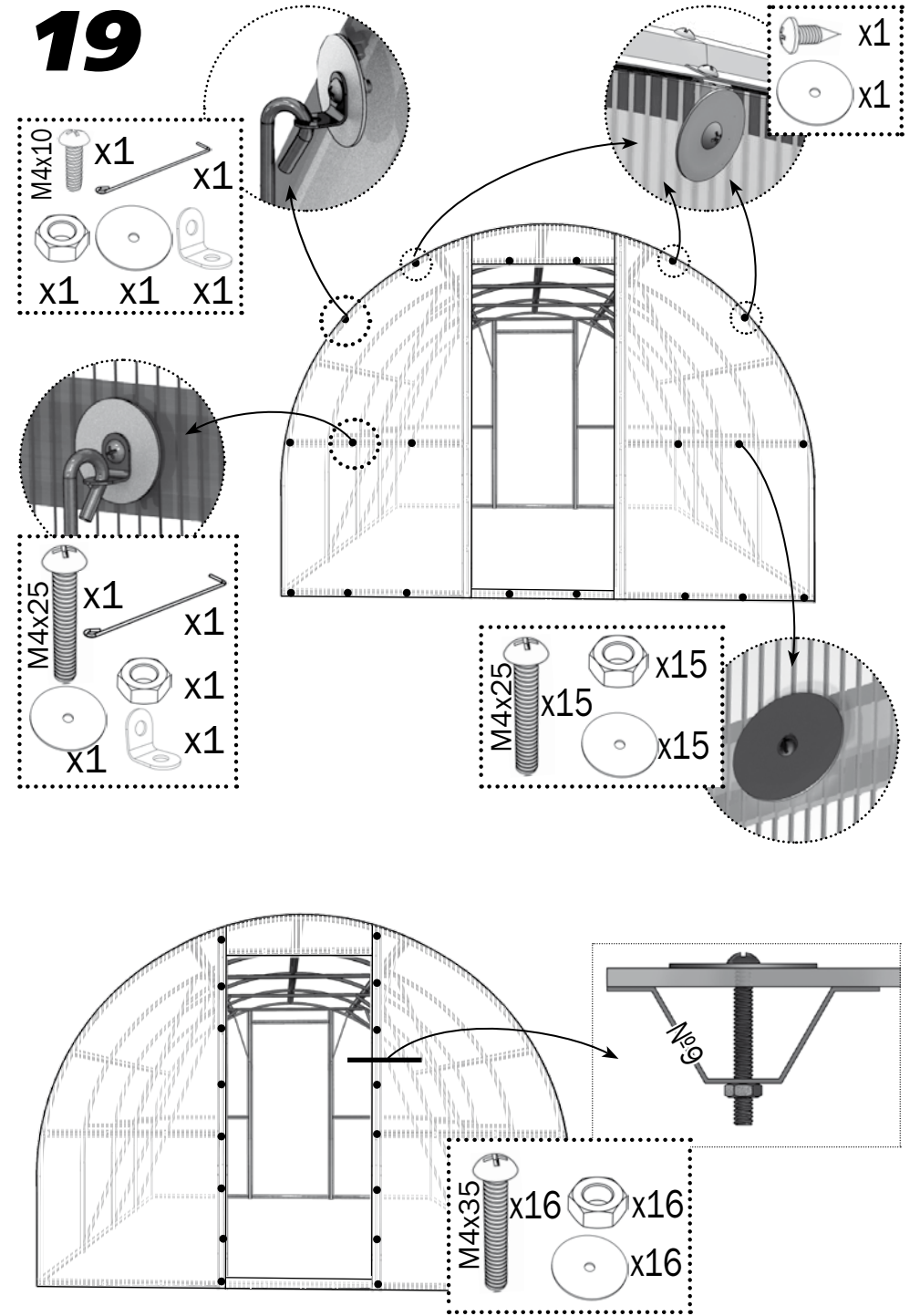

20

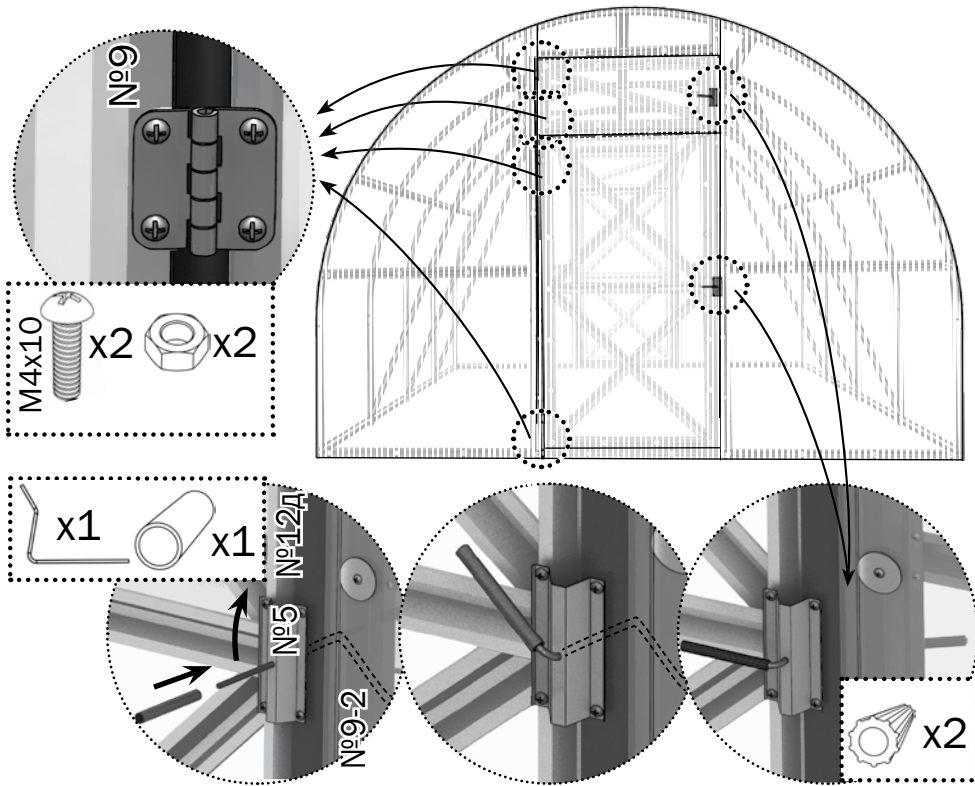

21

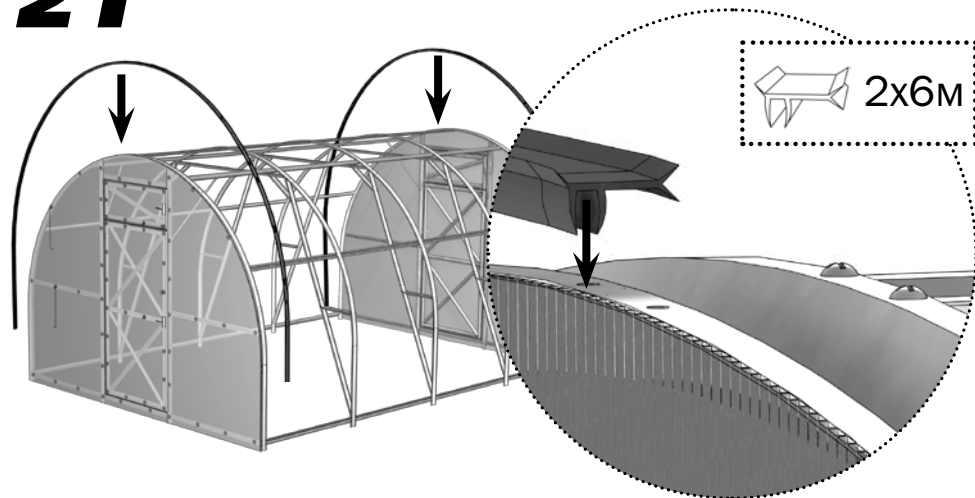

22

Cellular polycarbonate shall be installed strictly defined side out (towards the sun), which has a protective layer. The protective layer is usually at the side with the inscriptions on the transport film. The film on the other side of sheet is transparent. After marking the sheet, but prior to its cutting, make a mark on the protected side of the sheet for each piece: after removal of the transport film sheet sides are not visually different. The transport film is stripped from both sides immediately before fixing the cladding on the frame.

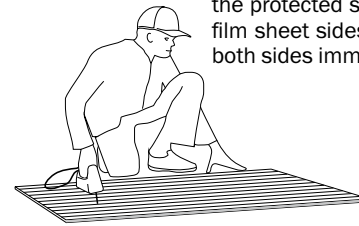

Sections of polycarbonate with open honeycombs should be covered by adhesive tape.

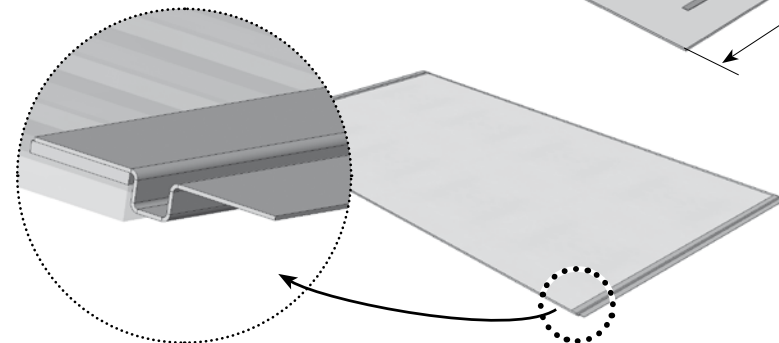
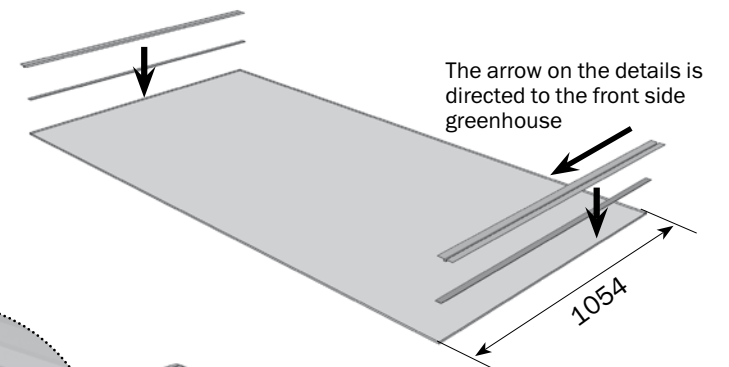
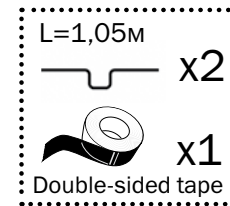
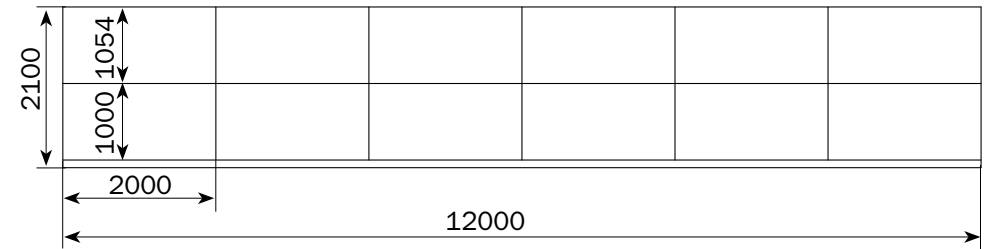
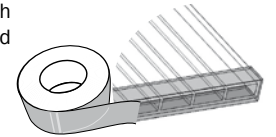

23

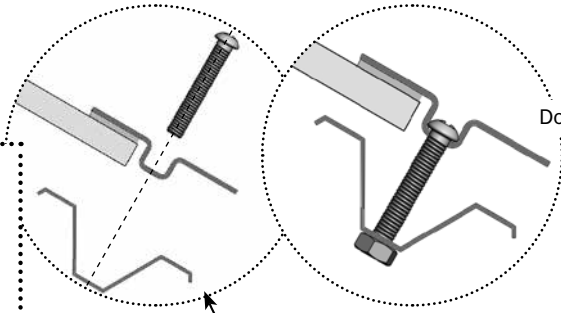
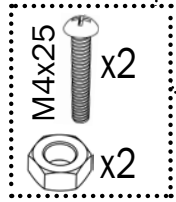

Do not fully tighten!

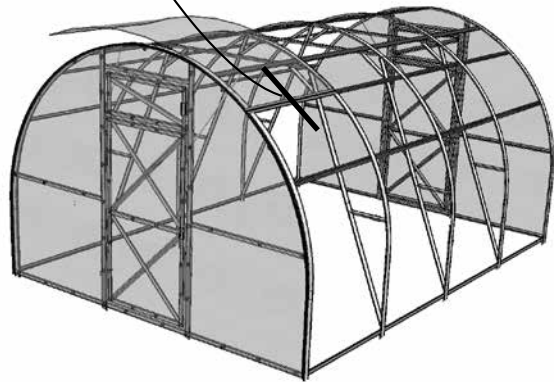

25

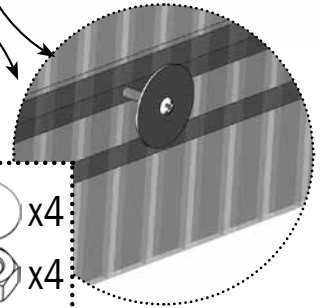
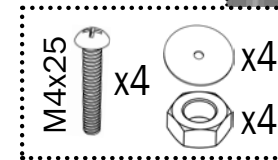
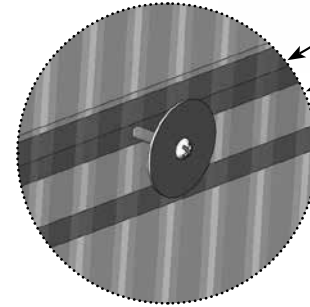
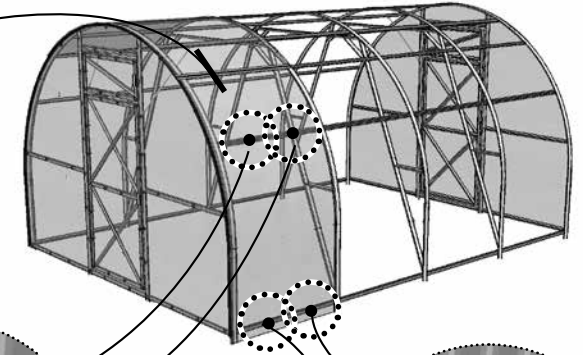
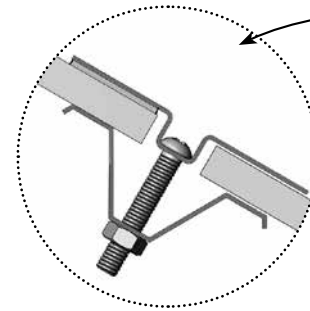

26

24

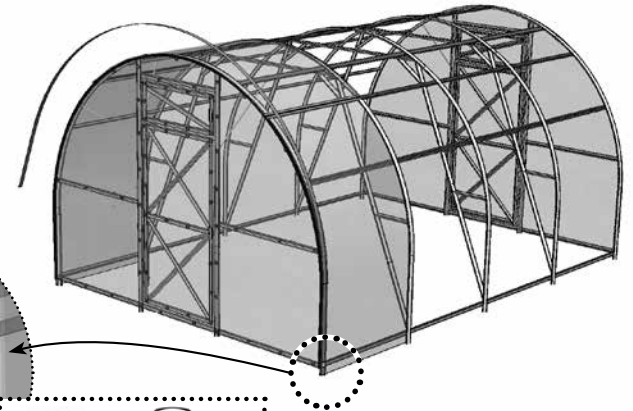
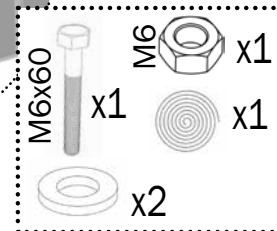
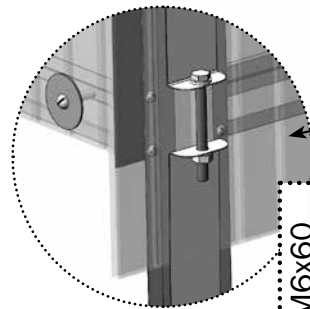
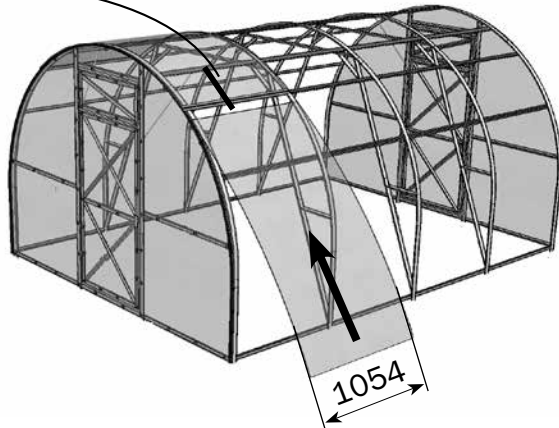
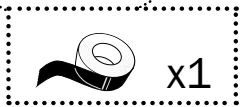
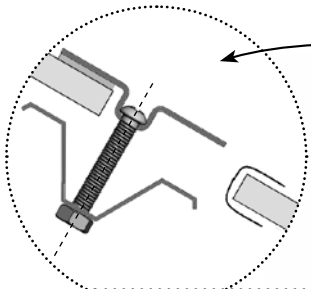

27

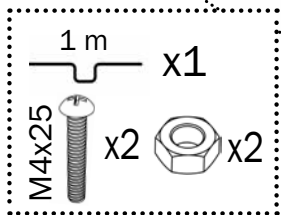
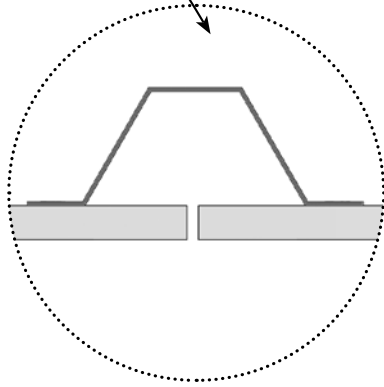
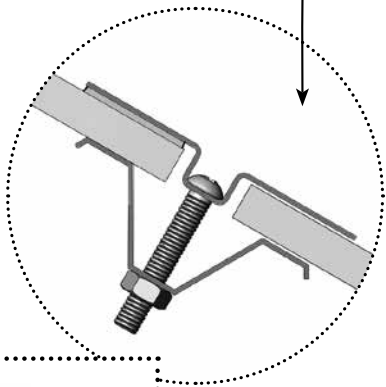
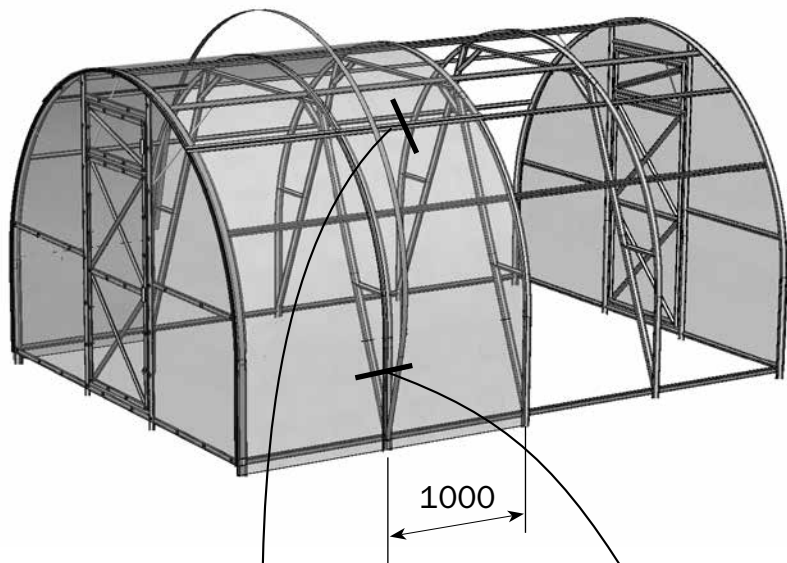

28

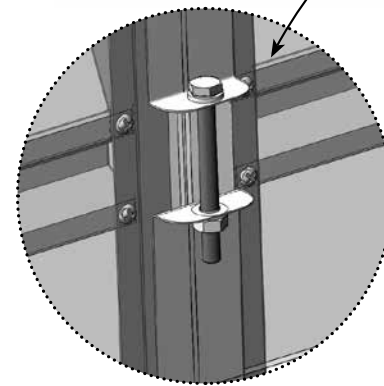
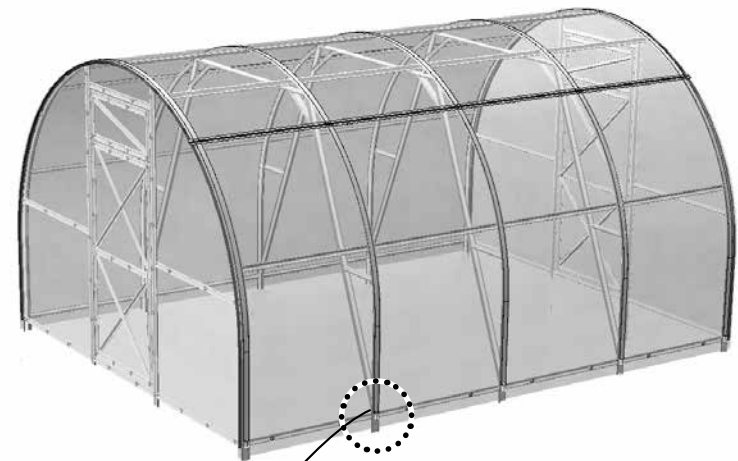

FOR INSTALLING ON FUNDAMENT

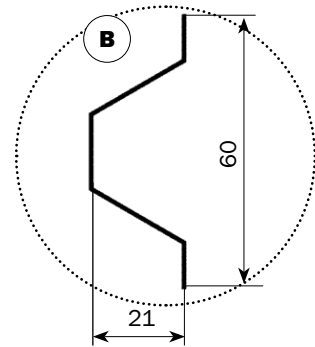
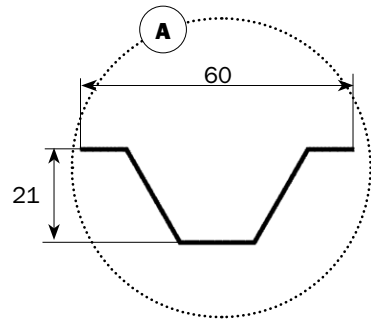
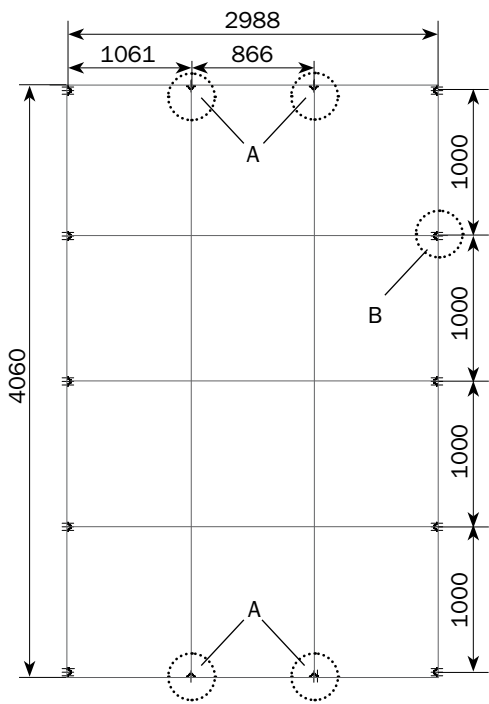
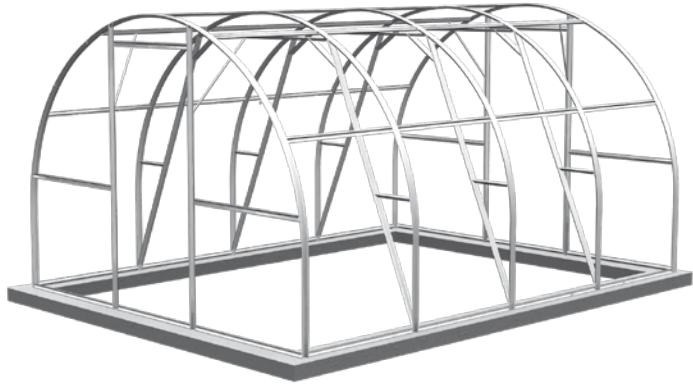



Manufacturer:
Volya LLC, Dubna, Moscow Oblast
Phone/fax: 8 (495) 598-5-999
www.perchina.ru
e-mail: info@perchina.ru

This manual may not be reproduced in any form in full or partially without written permission of Volya Company

EN